

PCME VIEW Ex 800 PCME VIEW Ex 820

ELECTRODYNAMIC™
INSIDE

Particulate

Measurement

System

Particulate Monitor
with Category 1
Ex approvals



ATEX
Category 1, 2 and 3

IECEX

Category 1, 2 and 3



- Category I certified for Ex (ATEX and IECEx) Gas Zones 0, I & 2 and Dust Zones 20, 21 & 22
- Intrinsically safe dust sensor with separate advanced control unit and isolating spur (fail-safe system)
- Unique *ElectroDynamic*™ dust measurement principle provides robust operation
- High temperature and high pressure sensor version available (PCMEVIEW Ex 820)



Certificate No: 9389

technology/applications

System Description

The **PCME VIEW Ex Series** instruments are used for particulate emission monitoring where category 1, 2 or 3 Hazardous area certification is required. The instruments are typically used after arrestment plant such as Bagfilters and Cyclones to monitor emissions, quantify particulate loadings in mg/m^3 and/or detect process upsets. The **PCME VIEW Ex Series** is suitable for temperatures and pressures found in most stack conditions, while the **PCME VIEW Ex Series** can tolerate the elevated pressure and temperatures found in coal gasification and certain combustion applications.

Ex Approvals and Safety Control

The **PCME VIEW Ex Series** are intrinsically safe certified particulate emission monitors suitable for Ex Gas and Dust Zones. The instruments are certified as Category 1 devices by the Notified Body, SIRA, UK according to both the ATEX Directive (94/9/EC) and IECEx requirements. As such they are suitable for use in both hazardous Gas Zones 0, 1, 2 and hazardous Dust Zones 20, 21, 22. The sensor electronics are certified intrinsically safe (ie fail-safe under two fault conditions) and are, therefore, suitable for installation directly in the hazardous Gas Zone. The control unit and isolating spur unit are located in the safe area. The sensor is connected via the isolating spur unit to the controller. The system uses galvanic isolation meaning that no independent, intrinsically safe earth is required. An 'Earth strap' connection is required between the sensor body and the stack as part of the system safety (see manual for further details).

Certification for Enclosure - Outside Stack

- Ambient temperature range of -20°C to 55°C
- Intrinsic safety for Gas Zone 0 (ia) to maximum surface temperature of 135°C
- Protection by enclosure for Dust Zone 21 (tb) to maximum surface temperature of 80°C

Certification for Sensor Rod - Inside Stack

- Probe temperature range of -20°C to 250°C (800 sensor) or -20°C to 400°C (820 sensor)
- Intrinsic safety for Gas Zone 0 (ia)
- Intrinsic safety for Dust Zone 20 (iaD)

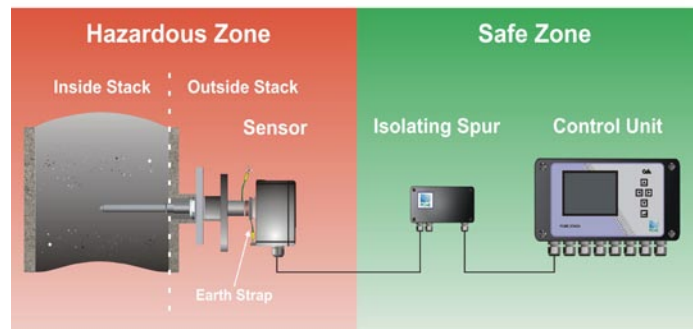

Process and Application Conditions

- Long term zero drift: $<0.1 \text{ mg}/\text{m}^3$
- Measurement capability: $0 - 500 \text{ mg}/\text{m}^3$
- For measurement in non-condensing flue gases
- For stack measurement but not suitable for Electrostatic precipitators or applications with water droplets
- For use in processes with flow of $8 \text{ m}/\text{s} - 20 \text{ m}/\text{s}$ with no restrictions
Constant velocity required outside this range
- For stack diameters: 100 mm to 6 m (flow profile dependent on larger stacks)

Principles of Operation

The **PCME VIEW Ex Series** instruments use PCME's unique and patented *ElectroDynamic™* Probe Electrification technology. The sensor electronics measures the current signature created by particles interacting with the grounded sensing rod which protrudes into the stack. The electronics extract a specific frequency band of this signal and electronically filters out the dc current caused by particle collisions. This signal may be correlated to dust concentration by comparison to the results of an iso-kinetic sample for those types of industrial stack applications for which the instrument is designed (see application conditions).

Core features of the *ElectroDynamic™* Probe Electrification technology are that the signal generated is:

- Unaffected by contamination on the sensor rod (which may cause signal drift issues for other systems).
- Not affected by velocity variations within typical bagfilter velocity ranges (see separate TUV approvals for PCME Ltd technology).
- Reliable and stable in the target applications for the instrument (see Process Conditions). Identical PCME technology to this is used in the PCME QAL 991 instrument which was the first ever probe electrification instrument to become TUV and MCERTS approved against the exacting standards of EN 15267-3 for QAL1.

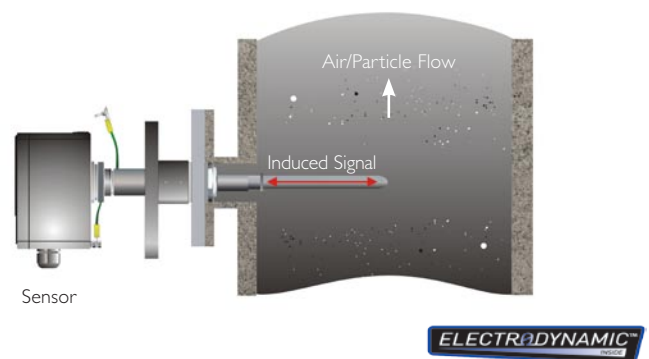

Technology Comparisons and Benefits

Compared to other types of AC systems, *ElectroDynamic™* systems have the following added benefit:

- An optimised frequency spectrum to extend the velocity range over which the system has no cross sensitivity to changing velocity (see TUV approvals).
- Protected probes or insulated rods are not permitted in hazardous zone applications.

Compared to DC triboelectric systems and 'induction sensing and protected probe systems', *ElectroDynamic™* systems have the following added benefits:

- Tolerance to contamination on the rod.
- Stable results and calibrations (protected probes are not necessary in dry applications and therefore drift caused by electrostatic charging effects is avoided).
- Reduced sensitivity to the effects of changing velocity.

product features

Added Value Features

The **PCME VIEW Ex Series** instruments include an advanced level of automatic functionality checks to provide high quality assurance:

- A probe rod short circuit check – enables the operator to know when the sensing rod may be electrically shorted to the stack and avoid associated errors.
- Automatic electronic zero and drift checks - improves measurement reliability and ensures that the instrument is working correctly. These checks are done in the sensor to ensure the major part of the instrument is challenged during these tests.

The system includes advanced signal processing and diagnostics to permit a plant operator to locate the position of leaking bags as well as improve the quality of emission measurement:

- Rapid dynamic ranging of 10,000:1 permitting bag cleaning pulses to be accurately monitored while maintaining high accuracy in background emission measurement. Sufficient dynamic range is provided to follow "on-line" and "off-line" bag cleaning cycles for predictive filter failure and faulty bag location detection.
- Rolling digital average calculations for accurate emission measurement.

System Layout

The **Standard** version of the instrument allows a single sensor to be installed and set-up remotely.

The **PLUS** version of the instrument permits up to 16 sensors to be connected to a single central control unit. The control unit provides power for the sensors (additional Power Supply Units (PSU) required on larger systems) and industry standard outputs (4-20mA, RS232/RS485 Modbus) are provided for easy connection to plant control systems. The Control Unit also comprises a powerful data logging capability to permit process and regulatory reporting. In addition, other PCME Modbus sensors can be connected to the Control Unit. An isolating spur is required for all sensors.

The **Entry** level Control Unit offers basic set-up and a 4-20mA output scaled to dust concentrations.

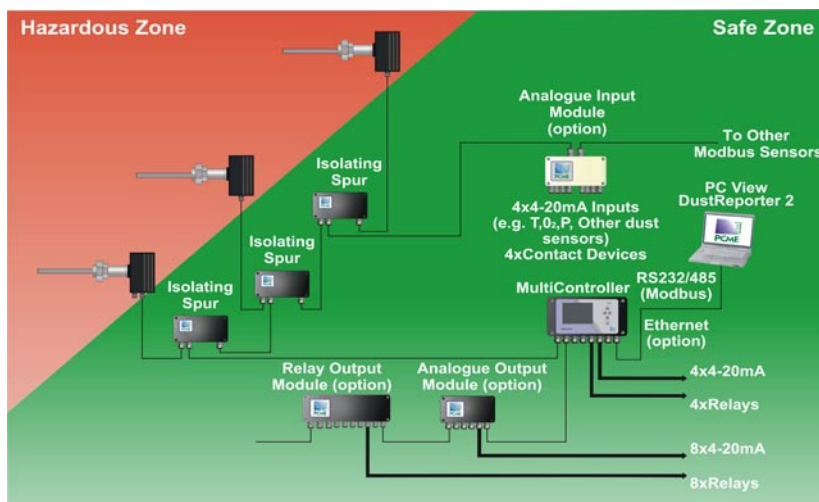

Control Unit Options

	Entry System	Standard System	PLUS System
Controller Type	Entry controller	Interface module	MultiController
No of Sensor Channels	1	1	1-16
ICON Driven Multilingual Menus	Not applicable (2 line LCD display)	Emission and Alarm levels Quality Assurance results Calibration screens Review data logs Show graph and bar chart Set up and password Advanced calculations (Mass, normalisation)	Emission and Alarm levels Quality Assurance results Calibration screens Review data logs Show graphs and multi bar charts Set up and password Advanced calculations (Mass, normalisation)
Bagfilter Optimisation Diagnostics	None	Pulse log review for diagnosing location of leaking bags	Pulse log review for diagnosing location of leaking bags
Emission Data Logs Long (averages for reporting) Short (process trends) Pulse data Alarms	None	Capacity stated for 1 sensor 12 months @ 15 minutes 7 days @ 1 minute 2 hours @ 1 second 500 entries	Capacity stated for 4 sensors 12 months @ 15 minutes 7 days @ 1 minute 2 hour @ 1 second 500 entries
Ethernet Enabled Option	None	None	Ethernet (Modbus TCP) (optional)
Outputs	1 x RS232 (Modbus RTU) optional 1 x 4-20mA (500 ohm) 1 x Relay (0.5A@110V)	1 x RS485 (Modbus RTU) 1 x 4-20mA (500 ohm) 2 x Relay (2A@250V, user selectable)	1 x RS485 (Modbus RTU) 4 x 4-20mA (500 ohm) 4 x Relay (2A@250V, user selectable)
Inputs	Input for plant off indication	1 input for plant off indication, bag cleaning reference and multiple calibrations	4 inputs for plant off indication, bag cleaning reference and multiple calibrations
Enclosure Size (mm)	220 W x 123 H x 80 D	220 W x 123 H x 80 D	263 W x 160 H x 91 D
Power Supply	90 to 260 VAC (50/60Hz), 1A	90 to 260 VAC (50/60Hz), 1A	90 to 260 VAC (50/60Hz), 1A

Cable Requirements

Cable specification (correct cable must be used)	4-core overall screened (specification on request)
Maximum cable length from Control Unit to Isolating Spur	500m
Maximum cable length from Isolating Spur to Sensor	500m

Isolating Spur (must be located in "safe" area)

Enclosure size	220 W x 124 H x 81 D
Enclosure rating	IP65
Power requirements	24VDC (supplied via cable from Control Unit)
Ambient temperature	-20°C to +55°C
Maximum cable length from Control Unit	500m

specifications

Dimensions

800 Type Sensor (0-250°C)

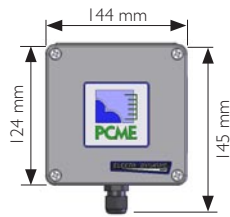
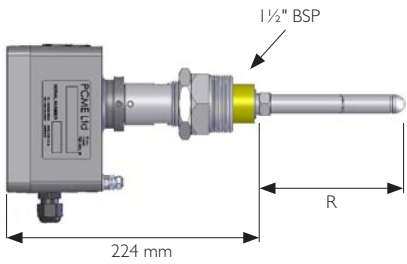

820 Type Sensor (0-400°C, 50 bar)

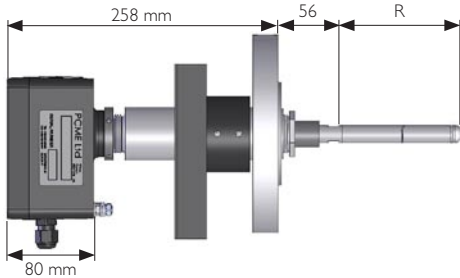

Isolating Spur Unit

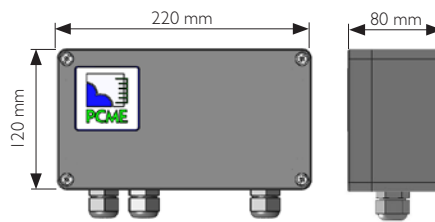

800 Stack Connection (1 1/2" BSP)

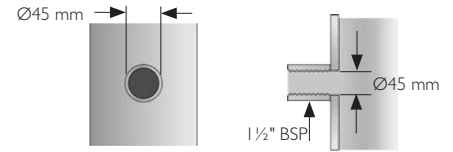

820 Stack Connection (DN40 PN64)

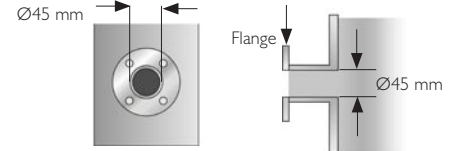

DN40 PN64 Flange

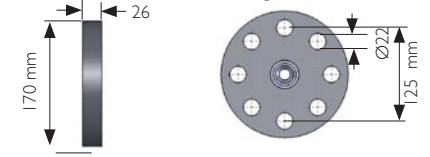

(NB This is an option for the 800 style sensor)

Order Codes

PCME VIEW Ex 8xx

Sensor Options

SEN 8xx - 1 2 3 4

1	Hazardous Zone Regulation	ATEX IECEX	ATEX IEC
2	Pressure	< 2 bar < 50 bar	2 50*
3	Stack Temperature	<250°C <400°C	250 400*
4	Rod Length	Specify Length	0100, 0200, 0300, 0400, 0500, 0600, 0800, 1000**

*820 only, **800 only

Example: SEN 8xx

1	2	3	4
ATEX	2	250	500

NOTE: An isolating spur is provided with each sensor

Control Unit Options

CON 8xx - A B

A	Controller	PLUS version (MultiController) Standard version (Interface Module) Entry version (Entry Controller)	M I E
B	Ethernet	None Ethernet fitted (PLUS version only)	0 ET

Example: CON 8xx

1	2
M	ET

System Options

4-core Cable (ATEX)	Specify length required (10m per sensor included as standard)	CAB4-A
Power Supply/Repeater	Voltage and signal boost for extended cabling runs with multiple sensors	PWR
Analogue Input Module (AIM)	4 x 4-20mA inputs 4 x Digital inputs	AIM
Analogue Output Module (AOM)	8 x 4-20mA (500 Ohm)	AOM
Alarm Output Module (ROM)	8 x Relay (1A @ 250V)	ROM
Isolating Spur (intrinsically safe)	Required for Ex	SPR-X-IS

NOTE: An isolating spur is provided with each sensor

PC Software Options PC-ME Dust Tools (RS232 required)

Configuration Options	System Set
Real-time Data Options	On-line Predict
Historical Data Options (Standard and PLUS only)	Data Downloader Data Viewer Data Reporter Predict View

About PCME Ltd

As a progressive environmental Company, PCME specialises in particulate measurement for industrial processes. With a worldwide reputation for reliability, innovation and technological excellence, the Company produces equipment for concentration and mass monitoring for regulatory, environmental and process control requirements. A dedicated team of qualified application and sales engineers is always on hand and should be consulted in the selection and usage of the most suitable equipment for any particulate application.

PCME Ltd
Clearview Building
60 Edison Road
St Ives Cambs UK
PE27 3GH

Contact your national or area sales and service office



Tel: +44 (0)1480 468200
Fax: +44 (0)1480 463400
E-mail: contact@pcme.co.uk
www.pcme.co.uk